



## NMT MINI 32/80-180

979525376

NMT MINI / Circolatore filettato ad altissima efficienza energetica

### GENERAL

Codice articolo	<b>979525376</b>		
Part name	<b>NMT MINI 32/80-180</b>	M e i	<b>/</b>
Seal type	<b>/</b>	EEl	<b>0,18</b>
Peso	<b>1,93 [kg]</b>		
H max	<b>8.2 [m]</b>	H min	<b>0.0 [m]</b>
Q max	<b>4.4 [m3/h]</b>	Q min	<b>0.0 [m3/h]</b>
	<b>[%]</b>		
Rumorosita' [dB(a)]	<b>≤43 dB(A)</b>		

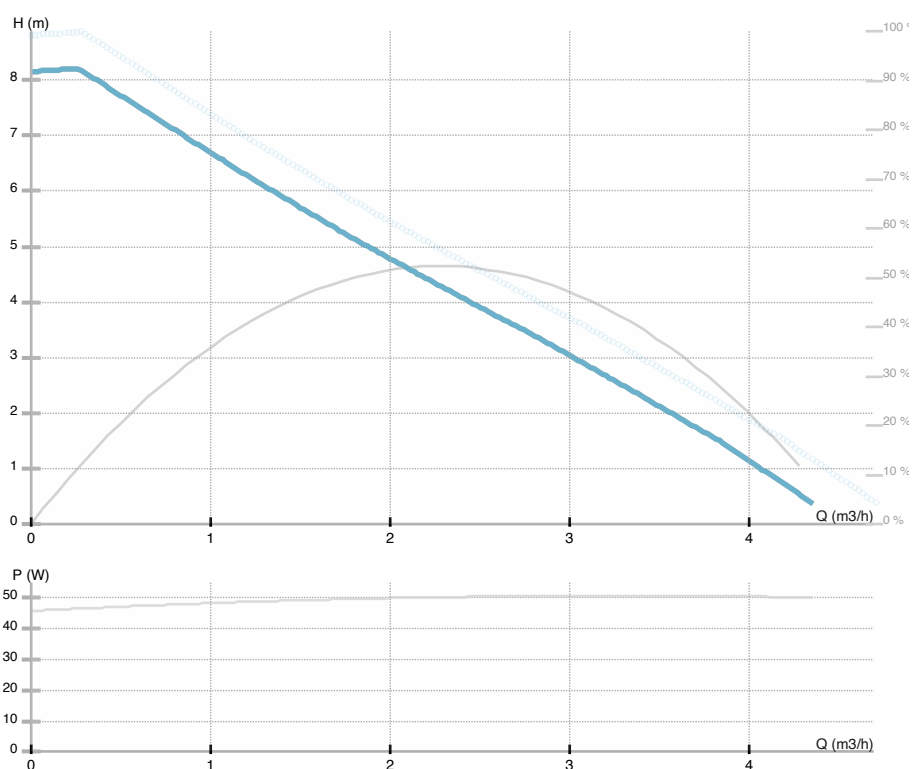

### ELECTRICAL DATA

Alimentazione	<b>1~230 V</b>
Frequenza	<b>50/60 Hz</b>
Potenza motore	<b>50 [w]</b>
Giri/min	<b>5600 [1/min]</b>
Classe di isolamento	<b>F</b>
Corrente nominale	<b>0.45 [A]</b>
Classe di protezione	<b>IP44</b>
Thermal protection	<b>NTC</b>
Frame size	
Motor i e class	<b>/</b>

### INSTALLATION

Fluidi consentiti	<b>Water VDI 2035, glycol 40%</b>
Temperatura fluido	<b>-10.0 ÷ 110.0 [°C]</b>
Temperatura max. ambiente	<b>40 deg C</b>
Interasse	<b>180 [mm]</b>
DN1	<b>32 [mm]</b>
Connettore	<b>G 2</b>
Connessione	<b>G 2</b>
Pressione massima	<b>1.0 MPa</b>

### MATERIAL

Materiale cuscinetti	<b>all carbon</b>
Materiale girante	<b>Noryl Fe 1630PW</b>
Material corpo pompa	<b>Ghisa</b>
Materiale albero	<b>AISI 420</b>

## **NMT MINI 32/80-180**

979525376

NMT MINI / Circolatore filettato ad altissima efficienza energetica





## NMT MINI 32/80-180

979525376

NMT MINI / Circolatore filettato ad altissima efficienza energetica

Disegno 1

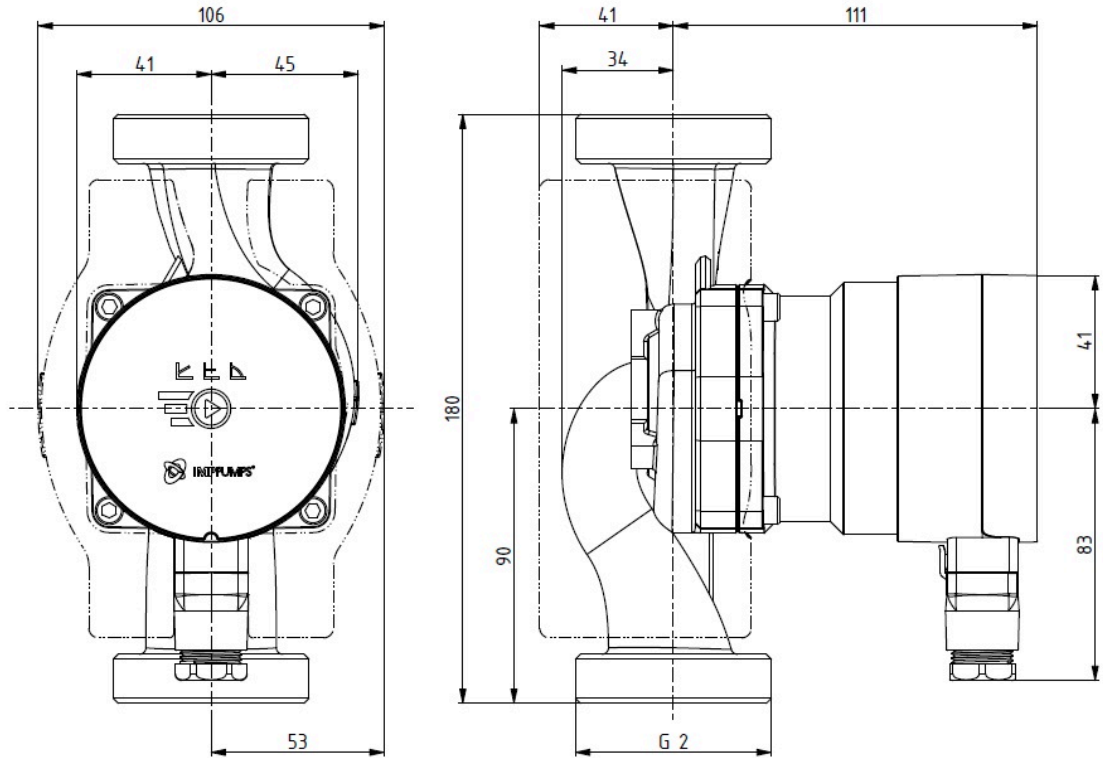



## NMT MINI 32/80-180

979525376

NMT MINI / Circolatore filettato ad altissima efficienza energetica

### Schema

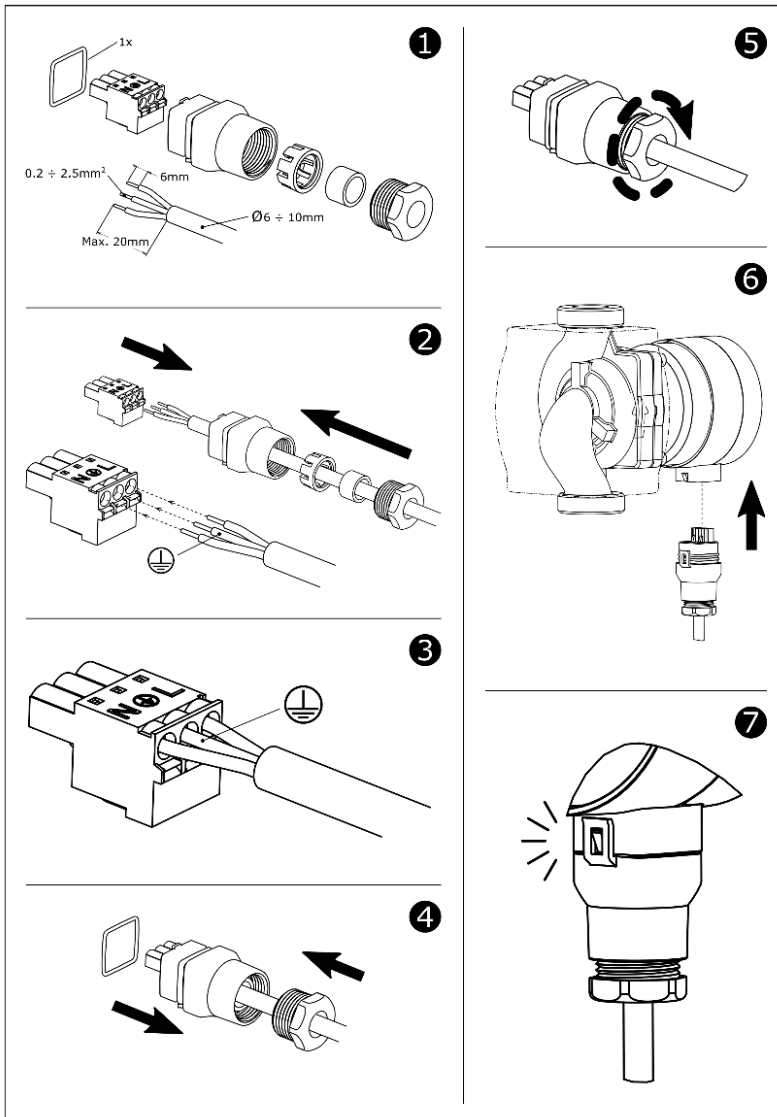



## **NMT MINI 32/80-180**

979525376

NMT MINI / Circolatore filettato ad altissima efficienza energetica